

Two PSIG Delivery Pressure Twin-Stage Regulators LV404Y9 & Compact LV404Y39

Application

SPECIAL 2 PSIG DELIVERY pressure twin stage regulator is designed to reduce container pressure down to 2 PSIG. A line pressure regulator is required downstream to reduce the 2 PSIG to a nominal 11" W.C.

Features

- Incorporates an integral relief valve in the 2 PSIG stage portion of the regulator.
- Designed to pass no more than 5 PSIG with the seat disc removed.
- Large vent helps prevent blockage and is tapped with a FNPT thread for piping away.
- Compact Design
- Built in pressure taps. Plugs can be removed with a 3/16" hex allen wrench.
- **Select Blue Finish** to designate 2 PSIG delivery pressure for 2- pound systems.

Materials

Body (First Stage)..... Brass
 Body (2 PSIG Stage) Die Cast Zinc
 Bonnet, Second Stage Die Cast Zinc
 Diaphragms Integrated Fabric and Synthetic Rubber
 Springs Steel and Stainless Steel
 Valve Discs Resilient Rubber



LV404Y9

LV404Y39

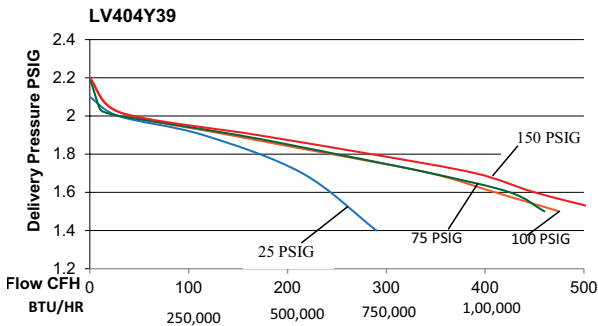
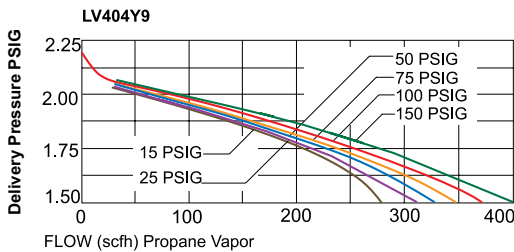
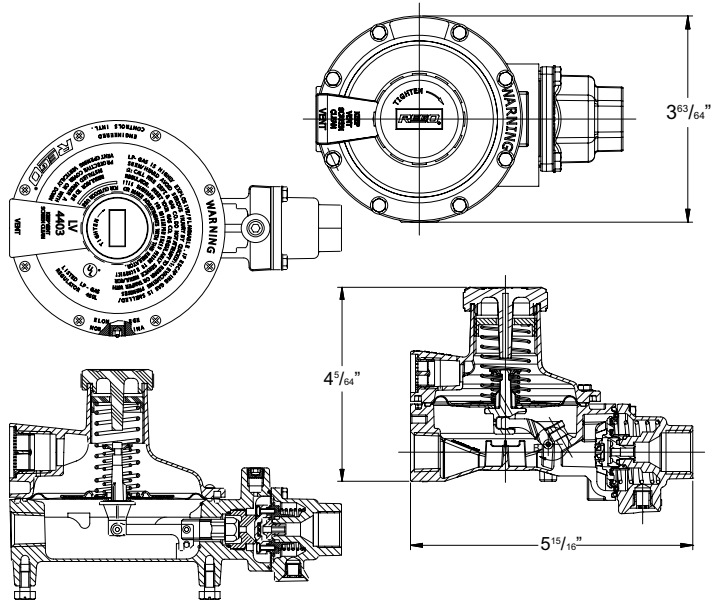

Ordering Information

Part Number	Inlet Connection	Outlet Connection	Orifice Size	Factory Delivery Pressure (PSIG)	Adjustment Range (PSIG)	Bonnet Vent Position 1st Stage	2 PSIG Bonnet Vent Position	Capacity BTU/HR*
LV404Y9	F.POL (CGA 510)	1/2" F.NPT	7/32"	2	1.8 to 2.5	Down	Outlet	800,000
LV404Y39								650,000

Maximum flow is based on 25 PSIG inlet pressure and 1.5 PSIG delivery pressure.